



Name Surname :

Class : 2 / 1 ...

Date : 03/02/2014

Aşağıdaki kelimeleri resimlerle eşleştirelim. Resimleri boyayalım.

Doctor

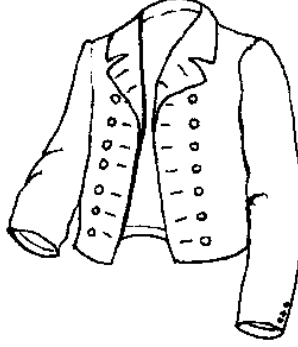

Television

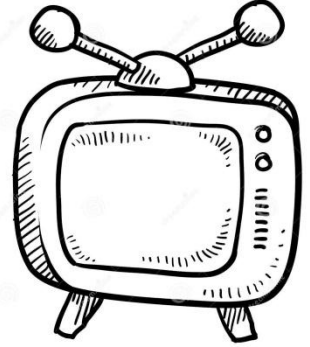

Football

Lemon

Kangaroo

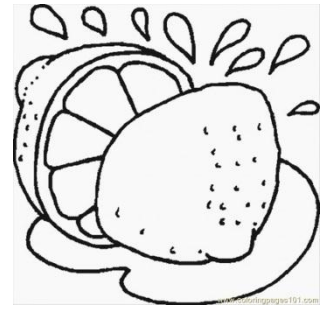

Police

Telephone



Jacket





Name Surname :

Class : 2 / ...

Date : 04/02/2014

Aşağıdaki kelimelerin üstlerinden geçelim.

Hello Hello Hello Hello Hello

Hi Hi Hi Hi Hi Hi Hi Hi

My name is

What is your name?

Good Morning

Good Afternoon

Good Evening

Good Night

Good Bye

Bye Bye



Name Surname : Class : 2 / 1 ... Date : 05/02/2014

Aşağıdaki kelimeleri resimlerle eşleştirelim. Kelimelerin üstünden geçelim.

Sit Down



Stand up



Close the door



Open the door

Turn Right



Turn Left

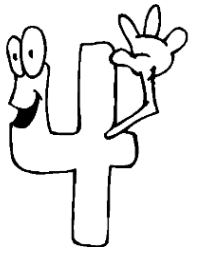

Name Surname : Class : 2 / ... Date : 06/02/2014

Aşağıdaki işlemleri İngilizce olarak yazalım.

$2 + 3 = 5$

$Two + Three = Five$

$1 + 6 = 7$

$3 - 2 = 1$

$4 + 2 = 6$

$9 - 1 = 8$

$9 - 5 = 4$

Aşağıdaki nesnelere sayıları yazalım.

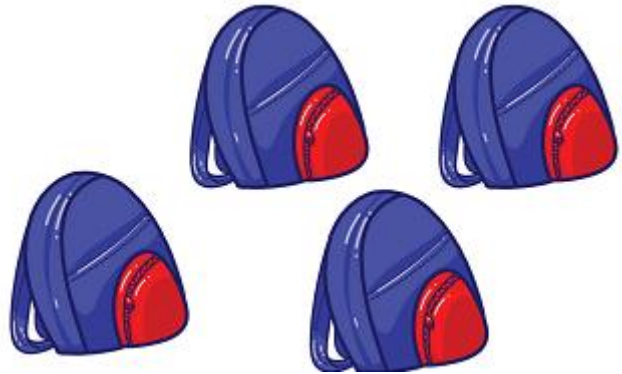

three books

four bags

three books

four bags



Name Surname : Class : 2 / 1 ... Date : 07/02/2014

Aşağıdaki nesnelere söylenen renge boyayalım. Kelimelerin üstünden geçelim.

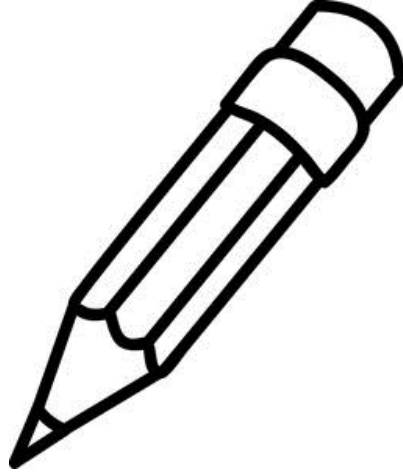
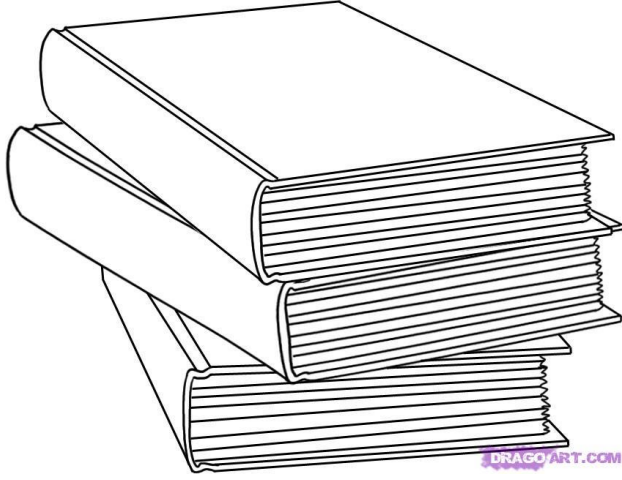

Color books red

Color pencil blue

Color bag pink

Red red red red blue blue blue pink pink

Yellow yellow yellow black black black orange gray

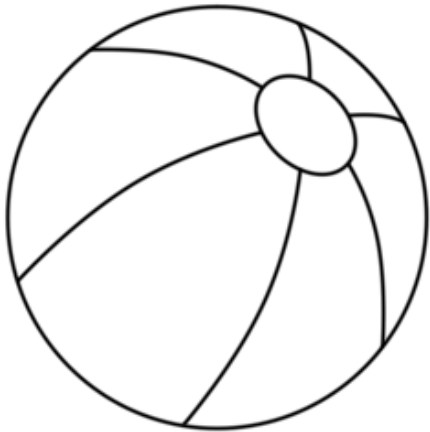

Color ball brown

Color lemon yellow

Brown brown brown brown green green green green

white white white white white white white